

## 版权声明

# RENLE

本资料使用的图片素材皆属实景拍摄，任何组织及其个人在未经允许的情况下，不得擅自转载和修改，产品及其技术描述，随着技术更新和改版，请及时关注雷诺尔科技官方网站：[www.renle.com](http://www.renle.com)，恕不另行通知，本资料最终解释权属上海雷诺尔科技股份有限公司。



## 雷诺尔

Shanghai RENLE  
Science&Technology Co., Ltd.

### 上海雷诺尔科技股份有限公司

Shanghai RENLE Science&Technology Co., Ltd.

地址：上海市嘉定区城北路3968弄188号1幢

邮编：201807

总机：021-59966666/021-59160000

传真：021-59160987

Http：[//www.renle.com](http://www.renle.com)

E-mail：[renle@renle.com](mailto:renle@renle.com)

全国免费服务热线：800-8200-785

2019年8月

Shanghai RENLE Science & Technology Co., Ltd

No.188 Building 1, Lane 3968, Chengbei Road, Jiading District,

Shanghai, 201807, P.R. China

Tel: +86-21-3953 8058, 5996 6666

Fax: +86-21-3953 8129

E-mail: [info@renle.eu](mailto:info@renle.eu)

RENLE Europe GmbH

WendemuthstraÙ5

22041 Hamburg

Germany

Tel: +49 40-2508 415

Fax: +49 40-5009 7043

<http://www.renle.eu>

National toll free service

Hotline: +86 800-8200-785

August, 2019



雷诺尔微信公众号

# RENLE

Professional Manufacturer of  
Smart Grid·New Energy·Electric Drive

## GCS系列

低压抽出式开关柜  
LV Draw-out Switch Cabinet



创芯科技·智惠全球  
股票代码：833586



## 雷诺尔

Shanghai RENLE  
Science&Technology Co., Ltd.



上海雷诺尔科技股份有限公司座落于上海市嘉定区国家级高新技术产业园区内，占地面积100000平方米，厂房85000平方米。产品覆盖高低压电机软起动器、高低压变频调速器、智能化电气、新能源电气和高低压输变电成套设备等，产品广泛应用于电力、冶金、石油石化、矿山、化工、建筑、建材、市政、军工业、轻工业、纺织印染、造纸、制药等行业。产品畅销世界多个国家和地区。

公司先后为上海世博会配套项目、北京奥运会配套项目、上海国际航运中心洋山深水港工程、上海浦东机场、上海虹桥机场、三峡工程、甘肃卫星发射中心、南水北调、西气东输、中国石油集团、中国石化集团等国家重点项目配套使用。优质的产品质量和良好的售后服务赢得了用户的一致好评。

公司严格控制产品质量，力争尽善尽美，构筑了坚实的质量系统工程，公司已获得ISO9001质量管理体系认证、ISO14001环境管理体系认证、欧共体CE认证，国家强制性CCC认证及产品检验认证。公司不断引进国际先进生产设备及检测设备，创建实验室，并为多个国内院校提供研发实验基地。公司一直注重自主创新，建立了颇具实力的新产品开发技术中心。

公司将不断地开发出节能、高效、精密、人性化的产品，以专业独特的工控技术、领先适用的创新产品以及深度整合的解决方案。帮助用户实现经济转型和产业升级，并加快国际化步伐，用品质征服世界，立志成为享誉全球的智能电气专业供应商！



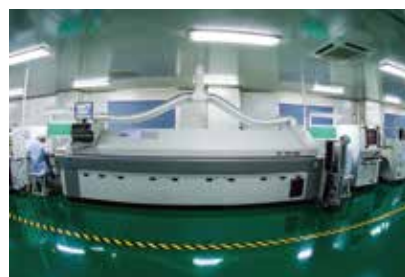

## 企业简介 Enterprise Introduction

Shanghai RENLE Science & Technology Co., Ltd is located in the High & New Technology Industrial Park of Jiading District, Shanghai, China. The company covers a total area of 100,000 square meters, including 85,000 square meters of workshops. Its products include HV/LV motor soft starter, HV/ LV frequency inverter, intelligent electricals, new-energy electricals, HV/LV complete equipment for electric power transmission distribution and so on. Its products are widely used in electric power, metallurgy, petroleum chemistry, military industry, mining, chemical industry, construction, light industry, pharmaceuticals, municipal construction, textile printing and dyeing, papermaking, rubber and plastic, electrified railway construction and other industries. Its products sell well in many countries and regions of the world.

The company products are used in many projects, such as Expo 2010 Shanghai China, 2008 Beijing Olympic Games, Yangshan Deepwater Port Project of Shanghai International Shipping Center, Shanghai Pudong Airport, Shanghai Hongqiao Airport, the Three Gorges Project, Gansu Satellite Launching Center, South-to-North Water Diversion Project, West-to-East Natural Gas Transmission Project, China National Petroleum Corp., SINOPEC, Double Coin Holdings, Shandong Linglong Tyre and other national key supporting projects. Its premium products and excellent after-sales service are favored by the clients.

Renle always lays emphasis on quality control so as to attain perfection. The company has passed the certification of ISO9001 Quality Management System, ISO 14001 Environment System, OHSAS 18001 Occupational Health and Safety Management System, CE, TUV, GOST and national CCC etc. RENLE has been continuously introducing internationally advanced production and test equipment to establish laboratories and provide R&D experiment base to domestic universities and colleges. The company, paying much attention to independent innovation, has established powerful new product R&D technical center.

The company shall keep developing products of energy-saving, efficiency, precision and humane. With the specialized and unique control technology, advanced and applicable innovative products, and deep-integrated solutions, the company helps clients in realizing economic transformation, industry upgrading and speedy internalization. With its high-qualified products, the company aims to be the world-renowned specialized manufacture of intelligent electrical equipment.

# GCS型 低压抽出式开关柜

## GCS Type Low-voltage switchboard of the draw-out version



### ► 型号及其含义 Type & Meanings

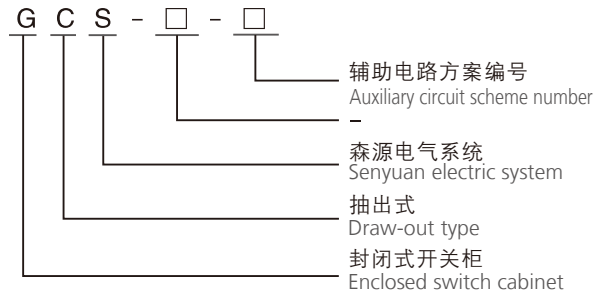

### ► 产品概述 Introduction

GCS型低压抽出式成套开关设备（以下简称“开关设备”）是我公司为满足广大设计单位和电力用户的要求设计研制出的符合国情、具有较高技术性能指标、能够适应电力市场发展需要并可与现有引进产品竞争的低压抽出式开关设备。该产品目前已被电力用户广泛选用。

开关设备适用于发电厂、石油、化工、冶金、纺织、高层建筑等行业的配电系统在大中型发电厂、石化系统等自动化程度高，要求与计算机接口的场所，作为三相交流频率为50（60）Hz、额定工作电压为380V（400V）、（660V），额定电流为4000A及以下的发、供电系统中的配电、电动机集中控制、无功功率补偿使用的低压成套配电装置。

本产品符合GB7251《低压成套开关设备和控制设备》、JB/T9661《低压抽出式开关设备》，同时满足IEC60439-1《低压成套开关设备和控制设备》标准。

GCS type low-voltage switchboard of the draw-out version (Hereinafter referred to as the switch equipment) is produced by our company according to the requirements of the common electricity users and designer units. The switch equipment meets the conditions of our country, has high technical performance index, applies to the developing needs of electricity market and completes with the currently introduced products. The switch equipment is now widely used by the electricity users.

The switch equipment applies to the electricity distribution system for the power plants, oil, and chemical industry, metallurgy, textile and high-rise construction etc. In places such as huge power plants, petrochemical industry system, which are highly automatic and should be interfaced to computers, it functions as the electricity distribution, the collective control of the motor and the low-voltage complete set of electricity distribution device, which is used for reactive-load compensation in the electricity generation and supply systems whose triphase AC frequency is 50 (60) Hz, rated working voltage is 380V (400V)(600V) and rated current is less equal to 4000A.

This product meets the following criteria: the GB7251 Low-voltage Complete Set of Switch Equipment and the JB / T9661 Low-voltage Draw-out Complete Set of Switch Equipment as well as the IEC60439-1 Integrated Low Voltage Switch and Control Equipment Standard.

## ► 使用条件 Usage Condition

- 周围空气温度：-5℃~+40℃；日平均温度不得高于+35℃。超过时，需根据实际情况降容运行。
  - 海拔高度：2000m及以下。
  - 相对湿度：相对温度为+40℃时不超过50%，在较低温度时允许有较大的相对湿度：如+20℃时为90%，应考虑到由于温度的变化可能会偶然产生凝露的影响。
  - 安装时倾斜度不超5°，且整组柜列相对平整（符合GBJ232-82标准）。
  - 开关设备应安装在剧烈振动和冲击以及不足以使电器元件受到不应有腐蚀的场所。
- 注：如上述使用条件不能满足时，应由用户在订货时向本司提出，协商解决。

- The surrounding temperature must be less equal to +40℃ and over equal to -5℃. The average temperature within 24 hours must be less equal to +35℃. If so, capacity should be dropped according to the practical situations.
- Altitude: be less than 2000m.
- Relative humidity: When the highest temperature is +40℃, the relative humidity of the temperature of the surrounding air must be less equal to 50%. At the lowest temperature, a higher humidity is allowed: for example, 90% when it is +20℃. The influence of the occasional appearance of the moist because of the variety of the temperature should be taken into consideration.
- The vertically of the installing device should be less equal to 5° and the whole group of boards should be relatively level. (Meet the GBJ232-82 criteria.)
- The device should be installed in places with on strenuous vibration and thrashing enough to corrode the electric components. If the users have special requirements, they can contact the producer and solve them together.

## ► 主要技术参数 Main Technical Parameters

主电路额定电压 (V) Main circuit rate voltage (V)		交流 AC380 (400)、(660)
辅助电路额定电压 (V) Auxiliary circuit rated voltage (V)		交流 AC220、380 (400) 直流 DC110、220
额定频率 (Hz) Rated frequency (Hz)		50 (60)
额定绝缘电压 (V) Rated isolation voltage (V)		660 (1000)
额定电流 (A) Rated current (A)	水平母线 Horizontal bus	≤4000
	垂直母线 Vertical bus (MCC)	1000
母线额定短路时耐受电流 (kA/1S) Rated withstand bus current during short circuit (kA/1s)		50,80
母线额定峰值耐受电流 (kA/0.1S) Rated withstand bus current during peak time (kA/1s)		105,176
工频实验电压 (V/1min) Power frequency experimental voltage (V/1min)	主电路 Main circuit	2500
	辅助电路 Auxiliary circuit	1760
母线 Bus	三相四线制 Triphase four wire system	A. B. C. PEN
	三相五线制 Triphase five wire system	A. B. C. N. PE
防护等级 Protection Level		IP30.IP40

## 主电路方案 Main Circuit Scheme

开关设备主电路方案共32组118个规格（见表2），不包括由于辅助电路的控制与保护的变化而派生的方案和规格。包括了发电、供用电和其它电力用户的需要，额定工作电流为4000A，适合2500kVA及以下的配电变压器选用。

此外，为适应供用电提高功率因数的需要而设计了电容器补偿柜；考虑综合投资的需要而设计了电抗器柜。

Main circuit scheme of the switchgear has 32 groups in total, namely 118 specifications (See the Figure 2). Of which exclude the ones for controlling and protecting the auxiliary circuit. The rated voltage is 4000A. It is a suitable option for the distribution transformer of 2500kVA and below.

In addition, a capacitor compensation cabinet is designed for the need of increased power factor, and a reactor cabinet is designed in consideration of the business investment.

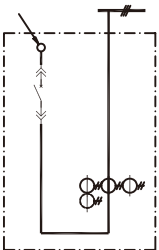
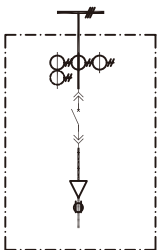
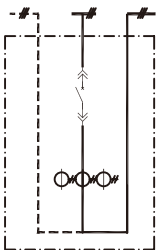
方案号 Scheme No.	01			02			03		
主电路方案图 Main Circuit Diagram									
用途 Usage	上进线 Upper incoming line			电缆下进线 Cable lower incoming line			联络 Contact Cabinet		
规格序号 Numbler	A	B	C	A	B	C	A	B	C
柜宽 (mm) Cabinet Width	600 (800)	800 (1000)	1000 (1200)	600 (800)	800 (1000)	1000 (1200)	600 (800)	800 (1000)	1000 (1200)
柜深 (mm) Cabinet Depth	800 (1000)	800 (1000)	800 (1000)	800 (1000)	800 (1000)	800 (1000)	800 (1000)	800 (1000)	800 (1000)
小室高度 (mm) Height of small room	1800	1800	1800	1800	1800	1800	1800	1800	1800
Imin(A)	1600	4000	6300	1600	4000	6300	1600	4000	6300
主要电器 Main Electricals	RNW1 630-1600	RNW1 2000-4000	RNW1 5000-6300	RNW1 630-1600	RNW1 2000-4000	RNW1 5000-6300	RNW1 630-1600	RNW1 2000-4000	RNW1 5000-6300
备注 Remark	1.可按用户指定断路器型号 2.若选4极断路器柜宽相应调整 3.可按需要增设计量装置			1.User can choose the type of circuit breaker. 2.Cabinet width shall be adjusted according to the choice of 4-pole circuit breaker. 3.Metering device shall be added according to the user.					

方案号 Scheme No.	04						05				06		
主电路方案图 Main Circuit Diagram													
用途 Usage	上出线 Upper outgoing line						下进线 Lower outgoing line				下进线 Lower outgoing line		
规格序号 Numble	A	B	C	D	E	F	A	B	C	D	A	B	C
柜宽 (mm) Cabinet Width	600 (800)	600 (800)	800 (1000)	800 (1000)	1000 (1200)	1000 (1200)	600	800	800	1000	600	800	1000
柜深 (mm) Cabinet Depth	600 (800)	600 (800)	600 (800)	800 (1000)	800 (1000)	800 (1000)	600 (800)	800 (1000)	800 (1000)	800 (1000)	600 (800)	600 (800)	600 (800)
小室高度 (mm) Height of small room	400	800	1200		1800	1800	800	1000	1400	1800	160 (200)	360 (400)	600
lmin(A)	250	400	630	1400	1600	2000	630	1000	1600	2000	100	250	400
主要电器 Main Electricals	RNW1 250	RNW1 400	RNW1 630	1000	RNW1 1600	RNW1 2000	RNW1 630	RNW1 1000	RNW1 1600	RNW1 2000	RNW1 100	RNW1 250	RNW1 400
备注 Remark	1.可按用户指定断路器型号。 1.User can choose the type of circuit breaker. 2.每台柜上出线只能出一路 2.Only one way for the outlet wire in each cabinet.						1.可按用户指定断路器型号。 1.User can choose the type of circuit breaker.						

备注：RNW1是主选断路器，也可选用其它性能更先进或进口F、MT系列断路器。

1、01、02、04方案如PE+N线需进入电源柜时柜宽用括号内尺寸。

2、SDL、SDH是GCS柜专用电源互感器。

Remark: RNW 1 is the main circuit breaker. Other circuit breakers with more advanced performance, such as the imported F and MT series, can be an option.

- ➔ 1、In case of the PE+N line enters the power cabinet of the Plans 01, 02 and 03, then the cabinet width shall
- ➔ 2、SDL and SDH are the specialized current transformer for the GCS cabinet.



方案号 Scheme No.	07				08		09		
主电路方案图 Main Circuit Diagram									
用途 Usage	上出线 Upper outgoing line				下进线 Lower outgoing line		母线转接 Bus switch		
规格序号 Numble	A	B	C	D	A	B	A		
柜宽 (mm) Cabinet Width	800	1000	800	800	600	800	400		
柜深 (mm) Cabinet Depth	600 (800)	600 (800)	600 (800)	800 (1000)	600 (800)	800 (1000)			
小室高度 (mm) Height of small room	160 (200)/2	160 (200)/3	360 (400)	480 (600)	360 (400)	600	1.当PC柜深1000mm同MCC柜单面操作且深600mm并柜时, 需要本方案。 This scheme is needed when the PC cabinet is 1000mm at depth and MCC cabinet is operated in the front and LCL is 600mm at depth.		
Imin(A)	100	100	250	400	63-250	400-630			
主要电器 Main Electricals	RNW1 100	RNW1 100	RNW1 250	RNW1 400	HH15 63-250	HH15 400-630	2.当MCC柜选用双面操作时, 必须加本方案。 This scheme is needed when the MCC cabinet is operated in the front and back.		
备注 Remark	1.可按用户指定断路器型号。 1.User can choose the type of circuit breaker.				1.可按用户指定隔离开关熔断器组。 1.User can choose the disconnectors with fuse.				

方案号 Scheme No.	10			11			12		
主电路方案图 Main Circuit Diagram									
用途 Usage	电动机不可逆 Motor irreversible			电动机可逆 Motor reversible			Y/Δ 起动 Strat		
规格序号 Numble	A	B	C	A	B	C	A	B	C
柜宽 (mm) Cabinet Width	800	800	800	800	800	800	800	800	800
柜深 (mm) Cabinet Depth	600 (800)	600 (800)	800 (1000)	600 (800)	600 (800)	800 (1000)	800 (1000)	800 (1000)	800 (1000)
小室高度 (mm) Height of small room	160 (200)	360 (400)	600	160 (200)	360 (400)	600	200	400	600
Imin(A)	100	250	400	100	250	400	100	250	400
主要电器 Main Electricals	RNM1 100	RNM1 250	RNM1 400	RNW1 100	RNW1 250	RNW1 400	RNW1 100	RNW1 250	RNW1 400
备注 Remark	1.可按用户指定元器件型号配。 1.Components type shall be equipped according to the user.								

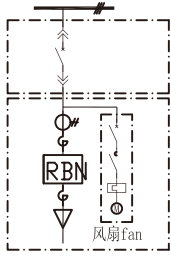
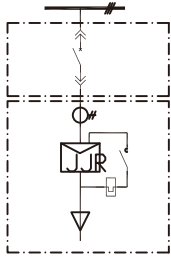
方案号 Scheme No.	13 非标 Self define			14 非标 Self define					
主电路方案图 Main Circuit Diagram									
用途 Usage	电动机可逆 Motor reversible			Y/Δ启动 Strat					
规格序号 Numbler	A	B	C	A	B	C			
柜宽 (mm) Cabinet Width	600	800	1000	800	800	1000			
柜深 (mm) Cabinet Depth	800 (1000)	800 (1000)	800 (1000)	800 (1000)	800 (1000)	800 (1000)			
小室高度 (mm) Height of small room	160(200) 800	360(400) 1000	480(600) 1200	160(200) 800	360(400) 1000	480(600) 1200			
Imin(A)	100	250	400	100	250	400			
主要电器 Main Electricals	RNW1 100	RNW1 250	RNW1 400	RNW1 100	RNW1 250	RNW1 400			
备注 Remark	1.可按用户指定元器件型号配。 1.Components type shall be equipped according to the user.								

见表1 See the Sheet 1

额定电流(A) Rated Current	铜母线规格(mm <sup>2</sup> ) Specification of the copper busbar(mm <sup>2</sup> )	选用PE(N)线截面(mm <sup>2</sup> ) Chose the PE (N) Line section (mm <sup>2</sup> )
630	50×6	40×4
1250	80×10	40×5
1600	100×10	50×5
2000	125×10	60×6
2500	2(100×10)	N:100×10 PE:60×10
3150	3(100×10)	N:2(80×10) PE:60×10
4000	3(125×10)	N:2(100×10) PE:60×10

备注：1.民用建筑项目，N线截面需调整。 2.通风型配电室可适当降低。

Remark:1.In the civil construction project, the section line N needs to be adjusted 2.Ventilated distribution room can reduce

方案号 Scheme No.	15			16(主柜) 16(Main cabinet)		16(付柜) 16(Auxiliary cabinet)	
主电路方案图 Main Circuit Diagram							
用途 Usage	无功补偿 Reactive compensation			无功补偿 Reactive compensation		无功补偿 Reactive compensation	
规格序号 Numbler	A	B	C	A	A		
柜宽 (mm) Cabinet Width	600	600	600	1000	1000		
柜深 (mm) Cabinet Depth	600(800)	600(800)	600(800)	800(1000)	800(1000)		
小室高度 (mm) Height of small room	1800	1800	1800	1800	1800		
最大补偿容量(kVar) Max.Compensation capacity	100	200	300	300	300		
主要电器 Main Electricals	QSA 250	QSA 400	QSA 630	QSA 630	QSA 630		
备注 Remark	1.可按用户指定元器件型号配。 1.Components type shall be equipped according to the user.						

方案号 Scheme No.	17			18(主柜) 18(Main cabinet)		18(付柜) 18(Auxiliary cabinet)		19	
主电路方案图 Main Circuit Diagram									
用途 Usage	无功补偿 Reactive compensation			无功补偿 Reactive compensation		无功补偿(SVG) Reactive compensation		无功补偿(SVG) Reactive compensation	
规格序号 Numbler	A	B	C	A	B	A	B		
柜宽 (mm) Cabinet Width	600	800	1000	1000	1000	1000	1400		
柜深 (mm) Cabinet Depth	600 (800)	600 (800)	800 (1000)	800(1000)	800(1000)	800(1000)	800(1000)		
小室高度 (mm) Height of small room	1800	1800	1800	1800	1800	1800	1800		
最大补偿容量(kVar) Max.Compensation capacity	100	200	300	300	300	400	600		
主要电器 Main Electricals	RNM1 225	RNM1 400	RNM1 630	RNM1 630	RNM1 630	RNM1 800	RNM1 1250		
备注 Remark	1.可按用户指定元器件型号配。 1.Components type shall be equipped according to the user.								

方案号 Scheme No.	20			21			22		
主电路方案图 Main Circuit Diagram									
用途 Usage	双电源自动切换(CB级) Dual-power automatic switch(CB Level)								
规格序号 Numbler	A	B	C	A	B	C	A	B	C
柜宽 (mm) Cabinet Width	800	1000	1200	600	800	1000	600	800	1000
柜深 (mm) Cabinet Depth	800 (1000)	800 (1000)	800 (1000)	600 (800)	600 (800)	600 (800)	600 (800)	600 (800)	600 (800)
小室高度 (mm) Height of small room	600 600	800 800	800 800	400	600	800	400	600	800
lmin(A)	1600	4000	6300	250	400	630	250	400	630
主要电器 Main Electricals	RNW1 630-1600	RNW1 2000-4000	RNW1 5000-6300	RNxx 250	Rnxx 400	Rnxx 630	RNxx 250	Rnxx 400	Rnxx 630
备注 Remark	1.可按用户指定断路器型号 2.柜宽按4极断路器考虑 3.可按用户需要增设计量装置 1.User can choose the type of circuit breaker. 2.Cabinet width shall be adjusted according to the choice of-pole circuit breaker. 3.Metering device shall be added according to the user.								

方案号 Scheme No.	23	24	25	26	27
主电路方案图 Main Circuit Diagram					
用途 Usage	电压互感器 Current Transformer				限流电抗器 Current limiting reactors
规格序号 Numbler	A	B	C	D	
柜宽 (mm) Cabinet Width	不占间隔, 可装在受电柜或母线转接柜内, 接在分支母线上。 Occupy no compartment, it can be installed in the brandch busbar inside incoming cabinet and busbar transfer cabinet.				600
柜深 (mm) Cabinet Depth					800
主要电器 Main Electricals	可按用户指定元器件型号配。 Components type shall be equipped according to the user.				限流电抗器3个 3 current limiting reactors 600A,0.0084Ω/Φ
			RNGR1	RNGR1	
	NT00	NT00			
	JDG-0.5 380/100		JDG-0.5 380/100		
		JSGW-0.5		JSGW-0.5	

## ► 主电路方案 Main Circuit Scheme

## ► 辅助电流方案 Auxiliary current scheme

GCS辅助电路图册共有辅助电路方案120个，分上下两册。上册《交流操作部分》共分63个方案，下册《直流操作部分》共有57个方案。

直流操作部分的辅助电路方案，主要用于发电厂变电站的低压厂（所）用系统。适用于200MW及以下和300MW及以上容量机组低压厂用系统，工作（备用）电源进线，电源馈线和电动机馈线的一般控制方式。

交流操作部分的辅助方案主要用于厂矿企业及高层建筑的变电所的低压系统。有6种适用于双电源操作控制的组合方案。并设有操作电气联锁备用自投、自复等控制电路，工程设计中可以直接采用。

直流控制电源为直流220V或110V，交流控制电源为交流380V或220V，由抽屉单元组成的成套柜。220V控制电源引自本柜内专设控制变压器供电的公用控制电源，公用控制电源采用不接地方式控制变压器，留有24V电源供需要使用弱电信号灯时采用。电度表的安装地点和电压的引入方法及其他安装使用要求详见辅助电路图的《编制说明》。

There are total 120 auxiliary circuit schemes in the GCS auxiliary schematics, divided into two parts. The first part named as AC Operations has 63 schemes, and the second one named as DC Operations has 57 schemes.

The auxiliary circuit schemes in the DC Operations are mainly used in the low voltage system of the power plant and transformer substation. They are adaptive to the low voltage system in the capacitor units of 200MW below and 300MW above. The power feeder and motor phase feeder adopts the normal control for incomings during power supply (backup).

The auxiliary schemes in the AC Operations are mainly used in the LV systems of transformer substations in the industry, minerals and high-risers. There are 6 schemes for the dual power operation and control. And an optional electrical interlock is equipped for the circuit control to reach the normal operation, which can be directly used in the engineering.

The DC control power is 220V or 110V, and the AC control power is 380V and 220V. The complete cabinet is composed of the drawer units. The 220V control power is from the common control power especially designed for controlling the transformer feeding inside the cabinet. The common control power adopts the non-grounded way to control transformer. And a 24V power supply is reserved for the weak current signal lamp.

Please see the Compilation and Explanation of the auxiliary circuit diagram for installations and operating requirements, such as meter installation and voltage introduction.

## ► 母线 Busbar

为提高母线动热稳定能力和改善接触面的温升，装置全部采用TMY-T2系列硬铜排、铜排的连接部分必须搪锡，推荐采用全长搪锡，也可选用全长镀银铜母线。

### a、水平母线

水平母线置于柜后部母线隔室内，2500A及以上为上下双层布置，2500A及以下为单层布置，每相由4条或2条母排组成，大大提高了母线的短路强度。

### b、垂直母线

用于抽屉柜的垂直母线采用“L”形硬铜搪锡母线。  
L形母线规格（mm）：（高×厚）+（底×厚）  
（50×5）+（30×5）  
额定电流1000A。

### C、中性接地母线

采用硬铜排。贯通水平中性接地线（PEN）或接地+中性线（PE+N）规格（见表4）。

In order to increase the dynamic thermal stability of the busbar and improve the temperature rise in the contact area, all devices adopt the TMY-12 series hard copper row. The connecting part of the copper bar must be tin coated. It is recommended to use tin-coating in full length, or use silver plating copper busbar.

#### Horizontal Busbar

The horizontal busbar is located in the busbar room behind the cabinet. For the ones of 2500A and above, use the double layer arrangement, otherwise, the single layer arrangement shall be used. Each phase is composed of 4 or 2 busbar rows, which improves the short circuit intensity of the busbar greatly. (See the Figure 3)

#### Vertical Busbar

The vertical busbar used in the drawer cabinet adopts the L shaped hard copper tin busbar.

Specification of L Shaped Busbar (mm):  
(Height×Thickness)+(Bottom×Thickness).

The rated current is 1000A.

#### Neutral Grounding Busbar

It adopts the hard copper row to connect the level neutral grounding line (PEN). See the sheet 4 for the specifications of grounding and neutral lines (PEN+N).



## ► 电器元件选择 Selection of Electrical Components

开关设备主要选用技术性能指标先进，采用引进技术国内已能批量生产的电器元件。

### a. 主开关

630A及以上的电源进线及馈线开关，主选RNW系列（也可以用DW40、DW48、CW1系列、AE系列、3WE系列、3WE），根据用户需要，也可选用进口的MT系列或F系列。

b. 630A以下的馈线和电动机控制用开关，主要选用RNM1塑壳开关也可以选用CM1系列、TM30系列塑壳断路器。

c. 交流接触器，主要选用B系列、LC1系列、3TB系列的接触器以及与之配套的热继电器、联锁机构。

d. 电流互感器全部采用森源电气有限公司监制的SDH、BH-0.66系列、SDL系列、SDL1系列。

e. 熔断器选用高分断能力的Q系列刀熔和NT00系列。

f. 为提高主电路的动稳定能力，设计了GCS系列专用的CMJ型组合式母线夹和绝缘件，采用高强度、阻燃型的合成材料热塑成型，绝缘强度高，自熄性能好，结构独特，只需调整积木式间块即可适用不同规格的母线。

g. 为降低功能单元的间隔板、接插件、电缆头的温升，设计了GCS柜专用的转接件，与同类产品比较转接件热容量增大，温升降低。

h. 如设计部门根据用户需要，选用性能更优良、技术更先进的新型电器元件时，因GCS系列柜具有良好的通用性，不会因更新电器元件，造成制造和安装方面的困难。

The switchgear mainly adopts the electrical components with advanced technical performance, which can be produced in batch domestically.

### a. Main Switch

The power incoming lines and feeder switch of 630A and above mainly choose the RNW series (The series of DW40, DW48, CW1, AE, 3WE are optional.). The imported series of MT and F are also an option according to the user.

b. The feeder and the switch in the drive mechanism of 630A and below mainly choose the RNMI plastic switch. The plastic circuit breaker in the series of CMI and TM30 are optional.

c. The A.C. contactor mainly chooses the series of B, LC1, and 3TB as well as supporting thermal relays and interlocking devices.

d. All the current transformers adopt the Shenyuan products in the series of SDH, BH-066, SDL AND SDL1.

e. The fuse adopts the Q and NT00 series knife fuse with high-breaking capacity.

f. In order to improve the dynamic stability of the main circuit, the specialized CMJ assembled busbar clamp and insulating support in the series of GCS is designed. It adopts the high-strength and fire-retardant synthetic material after thermoforming. With high insulation strength, excellent self-extinguishing performance and unique design, we only need to adjust brick-typed partition to install different busbars.

g. In order to reduce the temperature rise in the partition plate, plugs and cable heads of the function unit, the patchboard in the GCS cabinet is especially designed. Comparing with other products, the patchboard is enhanced in thermal capacity to reduce the temperature rise.

h. In choosing new electrical components with better performance and technology by the user, no difficulties in producing and installing of upgraded ones shall be caused due to the universal GCS cabinet.

见表3 See the Sheet 3

额定电流A Rated Current	铜母线规格(mm) Spec. of Copper Busbar
630 1250	2(50×5)
1600	2(60×6)
2000	2(60×60)
2500	2(80×10)
3150	2×2(60×6)
4000	2×2(60×10)

(mm<sup>2</sup>)表4 Sheet 4

相导线截面 Phase Wire's Cross Section	选用PE(N)线截面 Choose PE(N) Line Cross Section
500-720	40×5
1200	60×6
> 1200	60×10

## ▶ 主电路方案 Main Circuit Scheme

### ▶ 结构特点 Structure & Feature

GCS开关设备的主架构采用C型钢，架构采用拼装结构形式。主构架上均有安装模数孔E=20mm。开关设备各功能室严格分开，其隔室主要分为功能单元室，母线室、电流室、各单元的功能相对独立。

开关设备柜体的尺寸系列（见表5）。

The main frame of GCS series switchgear adopts assembled C-type steel. The main frame has an installation modulus hole. E=20mm. Each function room of the switchgear is divided into separate functional room, busbar room, and current room.

Dimension of Switchgear Cabinet Body (See the Sheet 5)

(mm)表2 Sheet 5

高 Height	2200										
宽 Width	400			600		800			1000		
深 Depth	800	1000	800	1000	600	800	1000	600	800	1000	

### ➔ 柜体简介 Cabinet Introduction

- 抽屉层高的模数为160mm。分为1/2单元、1单元、1.5单元、2单元、3单元五个尺寸系列。单元回路额定电流400A及以下。
- 抽屉改变仅在高度尺寸上变化，其宽度、深度尺寸不变。相同功能单元的抽屉具有良好的互换性。
- 每台MCC柜最多能安装11个一单元的抽屉或22个单元的抽屉。其中一单元以上抽屉采用多功能后板。
- 抽屉进出线根据电流大小采用不同片数的同一规格片式结构的接插件。
- 单元抽屉与电缆室的转接采用背板式结构ZJ-2型转接件。
- 1单元及以上抽屉与电缆室的转接按电流分档采用相同尺寸棒式或管式结构ZJ-1型转接件。
- 抽屉面板具有分、合、实验、抽出等位置的明显标志。
- 抽屉单元没有机械联锁装置。

- The module of the drawer height is 160mm, and is divided into 5 sizes, namely units of 1/2, 1, 1.5, 2, 3. The rated current of unit loop is below 400A.
- The change to the drawer differs in its height, not in its width and depth. The drawer with the same function unit can be interchanged.
- Each set of MCC cabinet can be installed with 11 one-unit s or 22 half-unit drawers at most. Of which the one-unit drawer adopts the multi-functional backboard.
- The inlet and outlet of the drawer adopts the slice connector with the same specification according to the current change.
- The conversion between the drawer unit and cable room adopts ZJ-2 typed patch board with a structure of backing plate.
- The conversion between the drawers with more than 1 unit and cable room adopts the ZJ-1 typed patch board with a pipe structure of the same size according to current category.
- Conspicuous marks of switch-on and off, test, draw-out and others can be seen the drawer panel.
- The drawer unit has not mechanical interlocking device.

### ➔ 功能单元 Function Unit

- 馈线柜和电动机控制柜设有专用的电缆隔室，功能单元室与电缆室内电缆的链接通过转接件实现，既提高了电缆的使用可靠性，又极大地方便了用户对电缆的安装与维修。
- 电缆隔室有二个宽度尺寸（240mm和440mm）可供选用，视电缆数量、截面和用户对安装维修方便的要求而定。考虑到干式变压器使用的普通性、安全性和油浸变压器的经济性，装置既可以方便地与干式变压器组成一个组列，也可以与油浸变压器低压母线方便连接。
- 以抽屉为主体，同时具有抽出式和固定式，可以混合组合，任意选用。
- 开关设备按三相五线制和三相四线制设计，设计部门和用户可以方便地选用PE+N或PEN方式。
- 柜体的防护等级为IP30、IP40，可以按用户需要特殊制作。

- A specialized cable room is installed for the feeder cabinet and motor control cabinet. The wire connections between its function unit and cable room is realized through patch board, which improvi the reliability in cable use and greatly benefit the wire installation and maintenance for the user.
- The cable room has two width dimensions (240mm and 440mm) for choice and use, determined by the cable quantity, cross section and user's demands on installation and maintenance. In consideration of the universality and security of the dry-typed transformer as well as the economical oil-immersed transformer, the device combines with the dry-typed transformer into a series, and connects with the low voltage busbar of the oil-immersed transformer.
- The drawer has both draw-out and fixed type, it can be combined and used at will.
- The switch equipment can be designed according to three-phase five-wire systems and three-phase four-wire system. The design department and user can choose the PE+N or PEN way conveniently.
- The protection level of the cabinet body is IP30 and IP40. And the protection level can be determined by the user.

▶ 产品外形及安装尺寸 Product Outline & Installation Dimension

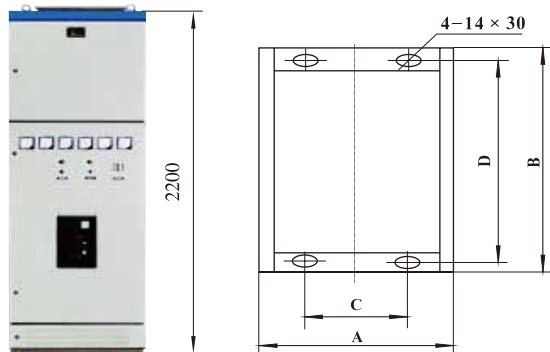
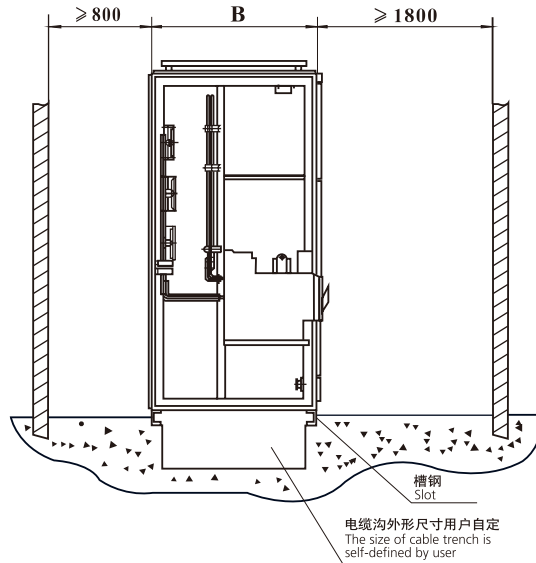

(mm)表7 Sheet 7

通用柜代号 Code for the general cabinet	A	B	C	D	备注 Remark
GCS-TG1010-4	1000	1000	900	956	联络柜 Contact cabinet
GCS-TG0810-4	800	1000	700	956	受电柜 Incoming cabinet
GCS-TG0808-4	800	800	700	756	受电柜 Incoming cabinet
GCS-TG0608-4	600	600	500	556	受电柜 Incoming cabinet

图1 受电、联络柜安装示意图  
Figure 1 Installation Diagram of Incoming and Contact Cabinets

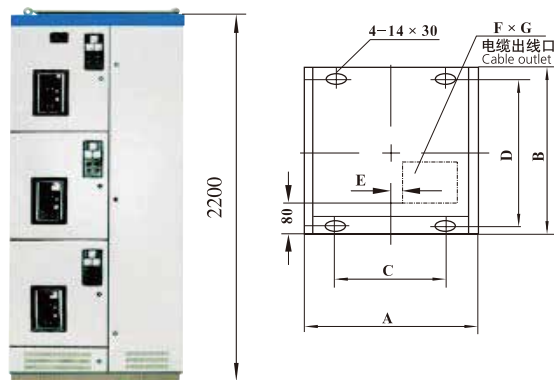
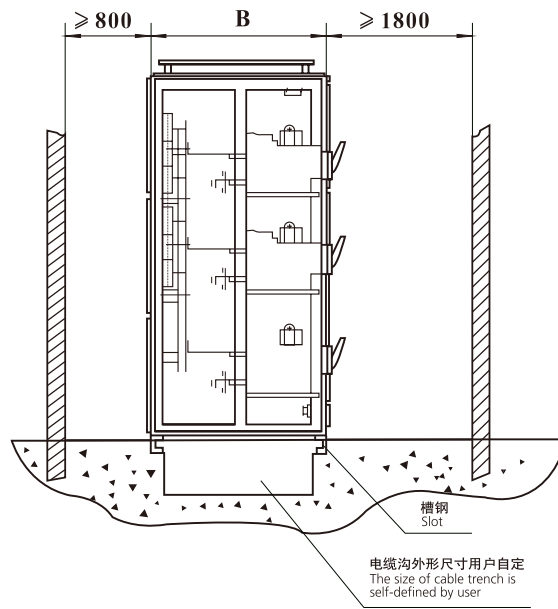

(mm)表8 Sheet 8

通用柜代号 Code for the general cabinet	A	B	C	D	E	F×G
GCS-TG1010-2	1000	1000	900	956	600	400×400
GCS-TG0810-2	800	1000	700	456	100	200×400
GCS-TG1808-2	1000	800	900	756	600	400×400
GCS-TG0608-2	800	800	700	756	160	200×400

图2 PC柜安装示意图  
Figure 2 Installation Diagram of PC Cabinet

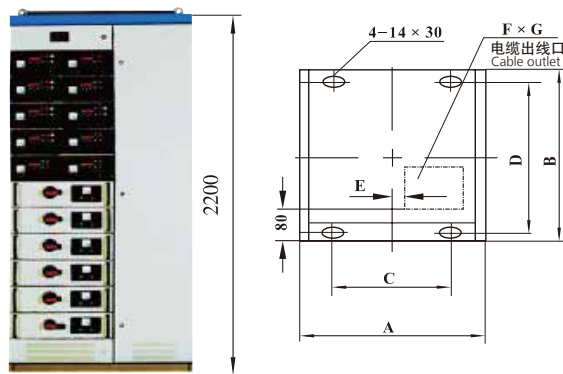
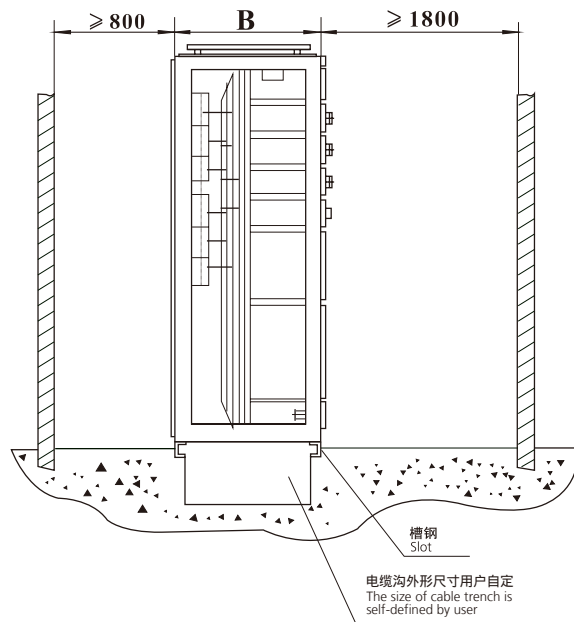

(mm)表9 Sheet 9

通用柜代号 Code for the general cabinet	A	B	C	D	E	F×G
GCS-TG1006-1	1000	600	900	456	60	400×350
GCS-TG0806-1	800	600	700	456	160	200×350

图3 MCC柜安装示意图  
Figure 3 Installation Diagram of MCC Cabinet

## 订货时应提供以下资料 Following documents shall be provided at ordering



订  
货  
须  
知

- 1、产品的全型号包括主电路方案号和辅助电路方案号；
  - 2、主电路系统组合顺序图；
  - 3、柜体平面布置图；
  - 4、辅助电路电气原理图；
  - 5、柜内元器件清单；
  - 6、电路中电压、电流、时间等整定参数；
  - 7、与产品正常使用不符的其他特殊要求。
- 1、 Model number of all products, includes ones of main and auxiliary schemes;
  - 2、 Combination diagram of main circuit system
  - 3、 Cabinet layout plan
  - 4、 Electrical schematic diagram of auxiliary circuit
  - 5、 Lists of main components inside cabinet
  - 6、 Voltage, current, time and other setting parameters in the circuit
  - 7、 Other special requirements in discrepancy with the normal use of product





**雷诺尔**  
Shanghai RENLE  
Science&Technology Co., Ltd.



▶ **国家重点項目 National Key Projects**



三峡工程  
Three Gorges Project  
北京奥林匹克水上公园  
Beijing Olympic Rowing-Canoeing Park  
北京奥运会配套项目  
Supporting Projects for the Beijing Olympic Games  
北京五棵松体育馆  
Wukesong Indoor Stadium  
国务院机关事务管理局  
Bureau of Government Offices Administration of the State Council  
中国中央电视台  
CCTV (China Central Television)



首都国际机场  
Beijing Capital International Airport  
二炮导弹基地  
China Second Artillery Corps Missile Base  
中国空空导弹研究中心  
China Air-to-air Missile Research Centre  
中国人民解放军空军雷达基地  
LA Air Force Radar Base



“南水北调”  
South-to-North Water Diversion  
黄衢南高速公路  
Zhejiang Huangqunan Expressway  
“西电东送”  
Electricity Transmission from West to East China  
“西气东输”  
West-East Natural Gas Transmission



上海磁悬浮轨道交通车站  
Shanghai Maglev Rail Transit Station  
上海世博会配套项目  
Supporting Projects for Shanghai Expo  
上海浦东机场  
Shanghai Pudong International Airport  
上海国际汽车博物馆  
Shanghai Auto Museum  
上海虹桥机场扩建工程  
Extension Project for Shanghai Hongqiao Airport  
内蒙古呼和浩特白塔机场扩建工程航站楼  
Terminal Expanded for Hohhot Baita International Airport  
沈阳奥体中心  
Shenyang Olympic Sports Center  
北京南苑机场  
Beijing Nanyuan Airport  
云南2409空军机场  
Yunnan 2409 Airforce Airport  
青岛奥体中心  
Qingdao Olympic Sports Center  
济南奥体中心  
Jinan Olympic Sports Center  
双流国际机场扩建工程  
Extension Projects for Chengdu Shuangliu International Airport



重庆袁家岗奥林匹克体育中心  
Chongqing Olympic Sports Center  
新白云国际机场  
New Baiyun International Airport  
武汉天河机场  
Wuhan Tianhe Airport  
上海地铁明珠三号线  
Shanghai Metro Line 3  
重庆国际会议中心  
Chongqing International Conference Centre  
山西万家寨引黄工程  
Shanxi Wanjiashai Yellow River Diversion Project  
青海小游山生态工程  
Qinghai Xiaoyou Mountain Ecological Project

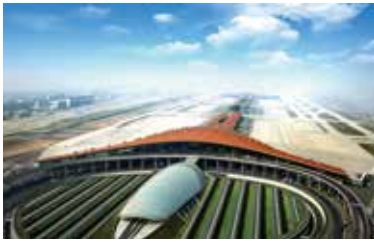

- 天津“八大片”供热工程
- Tianjin Badapian Heating Project
- 山东菏泽市引黄供水工程
- Shandong Heze Yellow River Diversion & Water Supply Project
- 上海国际航运中心洋山深水港工程
- Shanghai International Shipping Center Yangshan Deepwater Port
- 四川西昌卫星发射中心
- Xichang Satellite Launch Center
- 广西龙滩水电工程
- Guangxi Longtan Hydropower Project
- 甘肃卫星发射中心
- Gansu Satellite Launch Center
- 云南红河南沙水电站
- Yunnan Honghe Nansha Hydropower Station
- 大唐国际发电股份有限公司
- Datang International Power Generation Co., Ltd.
- 贵州开磷化工
- Guizhou Kailin Group Co., Ltd.
- 内蒙古神华集团有限责任公司
- Inner Mongolia Shenhua Group
- 金山石化
- Jinshan Petrochemical Company
- 上海宝钢集团
- Shanghai Baosteel Group
- 泰州石化
- Taizhou Petrochemical Company
- 鞍山钢铁集团
- Anshan Iron and Steel Group
- 吉林石化
- Jilin Petrochemical Company
- 武汉钢铁公司
- Wuhan Iron and Steel Group
- 广西柳化
- Guangxi Liuzhou Chemical Industry
- 中国首钢集团
- Capital Iron and Steel Company
- 广州石化
- Guangzhou Petrochemical Company
- 中国长城铝业公司
- China Great Wall Aluminum Corporation
- 洛阳石化
- Luoyang Petrochemical Company
- 广西平果铝业
- Guangxi Pingguo Aluminum Company
- 岳阳石化
- Yueyang Petrochemical Company
- 广西柳钢
- Guangxi Liuzhou Iron and Steel Group
- 南京石化
- Nanjing Petrochemical Company
- 马鞍山钢铁
- Maanshan Iron and Steel
- 北京燕山石化
- Beijing Yanshan Petrochemical Company
- 山西中阳钢厂
- Shanxi Zhongyang Steel
- 乌鲁木齐石化
- Urumqi Petrochemical Company
- 大庆油田
- Daqing Oilfield
- 锦西石化
- Jinxi Petrochemical Company
- 胜利油田
- Shengli Oilfield
- 独山子石化
- Dushanzi Petrochemical Company
- 辽河油田
- Liaohu Oilfield
- 北京金融街
- Beijing Financial Street
- 塔里木油田
- Talimu Oilfield
- 成都大熊猫生态园大熊猫博物馆
- Panda Museum in the Chengdu Ecological Park of Giant Panda
- 克拉玛依油田
- Karamay Oilfield
- 青岛北海船厂
- Qingdao Beihai Shipyard
- 陕西长庆石油
- Shaanxi Changqing Oilfield