



雷诺尔

Shanghai RENLE  
Science&Technology Co., Ltd.

RENLE

## Shanghai RENLE Science & Technology Co., Ltd

No.188 Building 1, Lane 3968, Chengbei Road, Jiading District,  
Shanghai, 201807, P.R. China  
Tel: +86-21-3953 8058, 5996 6666  
Fax: +86-21-3953 8129  
E-mail: info@renle.eu

RENLE Europe GmbH  
Wendemuthstraße 5  
22041 Hamburg  
Germany  
Tel: +49 40-2508 415  
Fax: +49 40-5009 7043

<http://www.renle.eu>  
National toll free service  
Hotline: +86 800-8200-785  
August, 2019



Technical innovation benefits the world  
RENLE Science & technology

### Copyright notice

All photographs in this catalog are taken on actual location. No organization or person is allowed to reprint or modify them without prior permission. The products and their description in this catalog are subject to upgrade with the renovation of the products. Please refer constantly to RENLE's official website: [www.renle.com](http://www.renle.com). Shanghai RENLE Science & Technology Co, Ltd reserves the right of final interpretation.

RENLE Science & technology



**RENLE**

JJR5000 series

**Motor Soft Starter**



**雷诺尔**

Shanghai RENLE  
Science&Technology Co., Ltd.



# RENLE

► Notification:

All the pictures are real ones from RENLE, which could not be used or revised by the third party without the permission from Shanghai RENLE Science & Technology Co., Ltd.. Please pay attention to our website: [www.renle.com](http://www.renle.com) for the latest revision. The right of final explanation belongs to Shanghai RENLE Science & Technology Co., Ltd..





## Professional Manufacturer Of Intelligent Grid And New Energy- RENLE

### COMPANY PROFILE

Shanghai RENLE Science & Technology Co., Ltd, is located in the High & New Technology Industrial Park of national level in Jiading District, Shanghai, China. It originates from Shanghai RENLE Electric Co., Ltd founded in 1999. The company covers a total area of 100,000 square meters, including 85,000 square meters of workshops. RENLE's products include LV/MV/HV motor soft starter, LV/MV/HV frequency inverter (VFD or AC drive), SVG compensation device and complete sets of LV/HV power transmission and distribution equipment etc. RENLE is a high-tech enterprise that integrates trade, R&D and production and a leading enterprise in the industry of intelligent electric drive in China. RENLE now owns five branch companies, namely Shanghai RENLE Power Automation Co., Ltd, Shanghai RENLE Switch Co., Ltd, Shanghai RENLE Power Supply Co., Ltd, Shanghai RENLE Explosion-proof Electric Co., Ltd and Shanghai RENLE Electronics Co., Ltd. RENLE has established more than 40 sales branch companies and 120 marketing offices throughout the country. The products are widely used in different kinds of industries and fields, such as electric power industry, metallurgical industry, petroleum and petrochemical industries, mines, chemical industry, construction industry, construction material industry, municipal engineering, military industry, light industry, textile, printing and dyeing, papermaking and pharmaceutical industries etc. RENLE's products are well exported to many countries and areas in the world.

RENLE's products have been used as parts of complete national key projects, such as Expo 2010 Shanghai China, 2008 Beijing Olympic Games, Yangshan Deepwater Port Project of Shanghai International Shipping Center, Shanghai Pudong Airport, Shanghai Hongqiao Airport, the Three Gorges Project, Gansu Satellite Launching Center, South-to-North Water Diversion Project, West-to-East Natural Gas Transmission Project, China National Petroleum Corp. and SINOPEC etc.

The company has passed the certification of ISO9001 Quality Management System, ISO 14001 Environment System, OHSAS 18001 Occupational Health and Safety Management System, CE, TUV, GOST and national CCC etc. The company has been honored with the titles of Shanghai High & New Tech Enterprise and National Enterprise Abiding by contract and valuing Credit. Its motor soft starter has been awarded with National Torch Plan Project in 2000; The RENLE products have been awarded with Shanghai Famous Brand Product, Shanghai Key New Product.





### ● Product Description

JJR5000 Series Intelligent soft starter adopts international advanced electronics technology, Microprocessor technology and modern control theory to efficiently limit start voltage of asynchronous motor. The equipment could be widely applied to fan,pump,conveyor, and compressor and other heavy load equipment. It is an excellent product to substitute traditional startup equipments such as star/triangle transition,self-coupling voltage reduction,Magnetron voltage reduction and so on.

### ● Typical Application

JJR5000 series intelligent soft starter could be widely applied to electric power, metallurgy, petroleum, petrochemical, mining, chemical industry, construction, building materials, municipal project, arm industry, light industry, textile, printing and dyeing, paper industry, and pharmacy and so on.

- Pump: make use of soft stop function to relieve the influence of water hammer so as to save system maintenance cost.
- Ball mill: make use of voltage ramp startup to reduce gear torque friction so as to save cost and time.
- Fan: reduce belt friction and mechanical conflict to save maintenance cost.
- Compressor: make use of current limitation function to realize smooth startup so as to reduce motor heating and prolong its service life.
- Conveyor: make use of soft start to realize smooth and gradual startup process in order to avoid product move and liquid overflow.

## ● Technical Characteristics

- Three kinds of optional starting parameters are available for one soft starter to drive different motor load.
- Dynamic fault record function which is convenient for seeking the reason of fault.
- Multiple protection functions: over current, three-phase current imbalance, overheat, phase loss and motor overload protection.
- Powerful software functions and many kinds of hardware to easily satisfy different site application request.
- Two communication protocols are optional: Profibus / Modbus
- Reasonable structure design to make installation easier and use more convenient.
- Humanization designed operation mode. Display window is optional: LED or LCD.
- Menu tree is grouped by function in order to make operation easier.

## ● Technical Features

- Main loop work voltage: AC380/500V (+10%-25%);
- Main loop work loop: 11A~1500A;
- Main loop frequency: 50Hz/60Hz (±2%);
- Control loop power supply: AC220V±15%(0.5A);
- Soft starting rising time: 1~120S;
- Soft stop time: 0~60S;
- Current limiting times : 1.5~5.0Ie;
- Initial voltage: 25%~80%Ue;
- Cooling method: natural cooling;
- Communication method: RS485 series communication;
- Starting times: < 10/h

## ● Usage and Environment Standard

Protection class	Ip00
Vibration resistance	comply with IEC 68-2-6: 2 to 13Hz is 1.5mm peak value;13 to 200Hz is 1gn
Impact resistance	comply with IEC 68-2-27: 15g, 11ms
Maximum ambient pollution class	Class 3, comply with IEC 947-4-2
Maximum relative humidity	93% no condensing or drip. Comply with IEC 68-2-3
Ambient temperature	Storage: -25°C to +70°C Running: 10°C to +40°C without derating. Maximum +60°C. 2% Above 40°C, the current will reduce by 2% for temperature rising for per 1°C.
Maximum running altitude	2000m without derating( above 2000m, current will reduce by 0.5% altitude rising for per 100m)
Running position	vertical position, between ±10°

## ● Relationship between Altitude and Output Rating Ratio

Altitude	Output current rating ratio
Below 2000m	1.00
2000m-2500m	0.91
2500m-3000m	0.88

## ● Instruction for Product Model

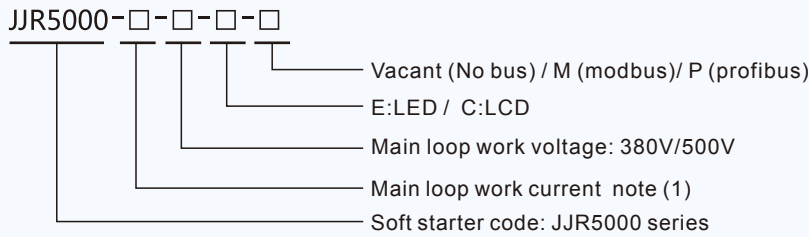

## ● Notice for Model Selection

- Soft starter must supply bigger torque than load resistance torque to complete start of related equipments such as pump, centrifugal pump. Single start constant load: permitted 40s for startup under 3 times limited current; permitted 25s for startup under 4 times limited current.
- Recycle start: if starting motor 10 times every hour, permitted 25s for startup under 3 times limited current; and per-mitted 15s for startup under 4 times limited current. Now the correspondent heat protection level is class 10.
- Permit to start heavy load motor such as ball mill, fan 5 times every hour. If limited current value is as above, the protection level is class 20. If increasing startup frequency, we have to adopt bigger power level product.

## ● Working principal

Main circuit of JJR 5000 soft starter adopts 6 SCRs (anti-parallel connected in series) connecting with stator circuit of AC motor. Based on function of SCR electronic switch, the soft starter makes use of microprocessor to adjust trigger angle to change SCR's conducting angle, so as to change motor input voltage value to realize the control of motor soft start. When completing the start, the output of soft starter will reach rated voltage. Then contactor KM which controls three-phase bypass will switch on to make motor run into the grid.

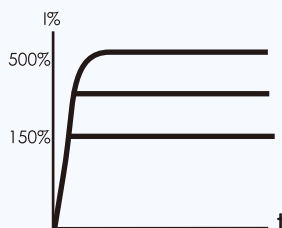
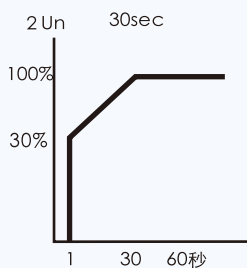
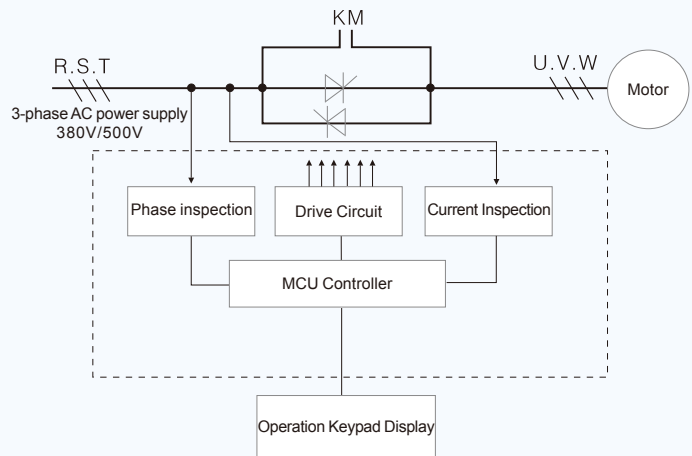

## Voltage Mode

Initial motor torque: When the frequency is a constant value, motor torque is proportional to the square of the applied voltage.

Setup range: 30%-80%. When adjusting the parameter, the user has to consider current impact and mechanical impact. If the value is too big, it will lead to a very big initial current. And then current impact and mechanic impact will be too much more. Under voltage mode, current will change with the exact load. But if max. value is limited on 5 times rated current, the user could increase start time to reduce its start current. When the load is light or empty, it will also complete start process even though it does not reach setup rising time because of motor potential energy which has accelerated the establishment.

## Limit Current Start

Max. permitted Current during motor start.

Setup range: 150-500%FLA( motor rated current). If asking for an extending range, please contact the manufacturer. If the setup value is too big, the motor will get bigger current from the main circuit to accelerate its speed. If the setup value is too small, it will cause that the motor still could not reach the full speed after completing its acceleration process. In order to help start current quickly reach limited value, it's better to setup start time short.

## ● Motor and system protection functions

JJR5000 series soft starter provides many kinds of protections upon motor and soft starter.  
The main functions are as below:





1. Protection for three-phase input phase failure. It won't start unless there is load with power supply from main loop and three phases.
2. Protection for overheat. Monitor the temperature. Frequent starts will lead to too high SCR's temperature. (Over 80 °C)
3. Protection for overlong start time. It is not good for motor and soft starter if start time is too long. So the default limit for start time is 30s. And the user could set up this time between 10~300s in accordance with exact load.
4. Protection for big current belongs to timing limit. If the current is over 5~8 times (available for setup), it will cut off output within 20ms ~200ms( available for setup).
5. Protection for inverse overload. There are 4 grade curves stall protection.
6. Light load alarm; trip protection, frequency mistake alarm.
7. Optional for choosing function of 'prohibiting start'. It will only permit restart when temperature of the motor reaches an expected value.

## ● Humanized Operation Interface

- **LED Indication Light** There are 8 LED lights on the display panel to indicate soft starter's status.

power	Power indication	Green ●	On=Control system is supplied with power
start	Start indication	Green ●	On=Control system is supplied with power Off=Motor stopped Flash=Motor is starting
Moto	Motor failure	Red ●	On=Motor fault indication, such as overload, locked rotor, etc.
equ	Equipment failure	Red ●	On=Soft starter's failure, such as input phase failure, thyristor overtemperature
bus	Bus indication	Green ●	On=Normal communication (See communication manuals)
A		Green ●	On=Current (unit:A)
SEC		Green ●	On=Time (unit:second)
%		Green ●	On=Current/voltage percentage

### ● Key Function Description:

-  **RUN** Start key: Start the motor, must set the control source
-  **STOP** Stop key: Stop the motor, must set the control source
-  **SET** Parameter setting key: Enter the next level of menu, key of saving the parameter
-  **EXIT** Return key: Exit from the previous menu
-  Plus or minus key: increase and decrease key for menu and setting parameters

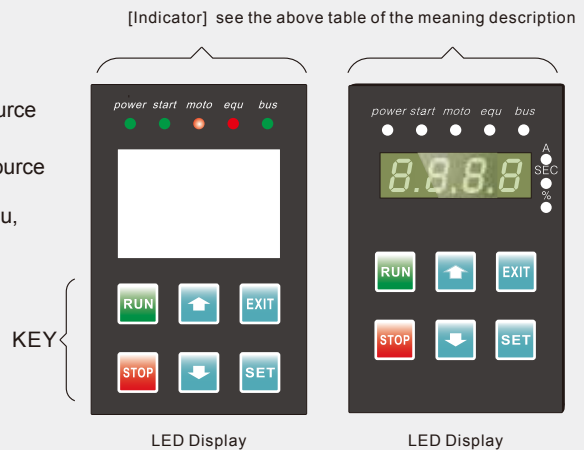



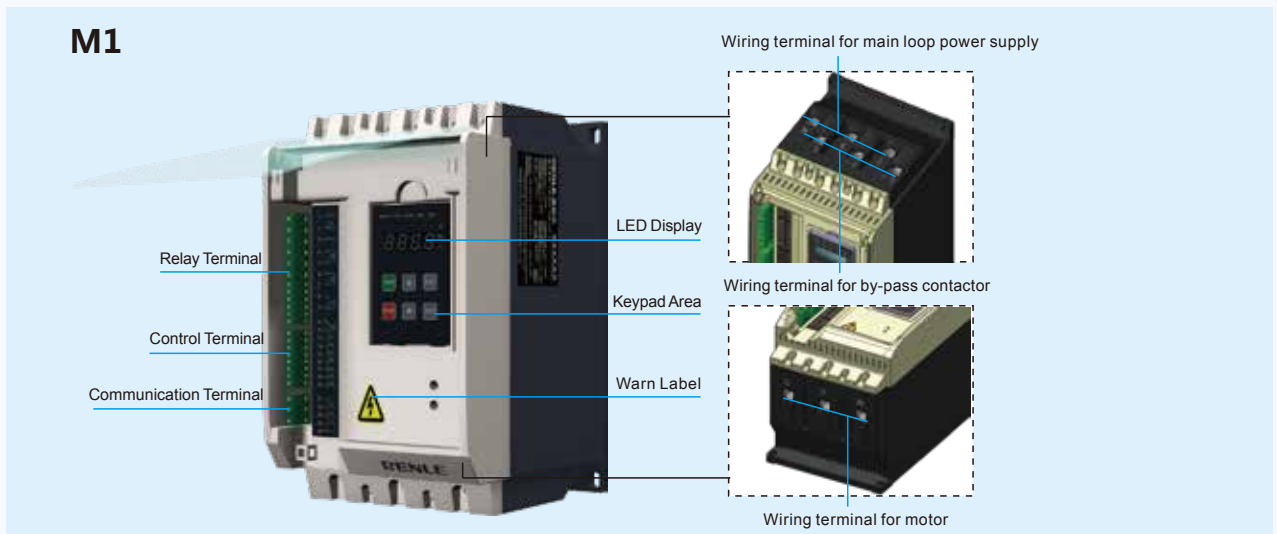

## ● Outline and wiring terminals

RENLE

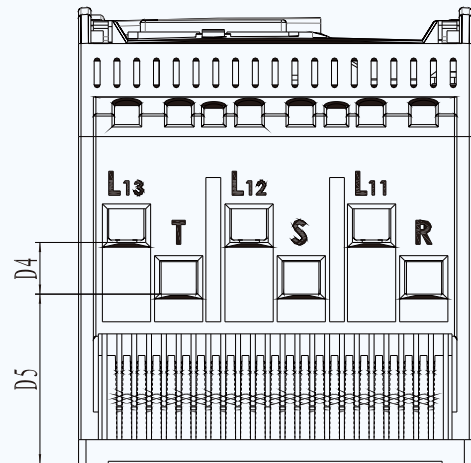
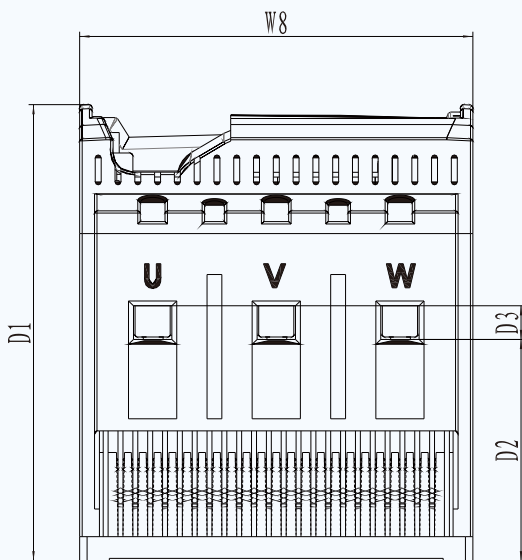
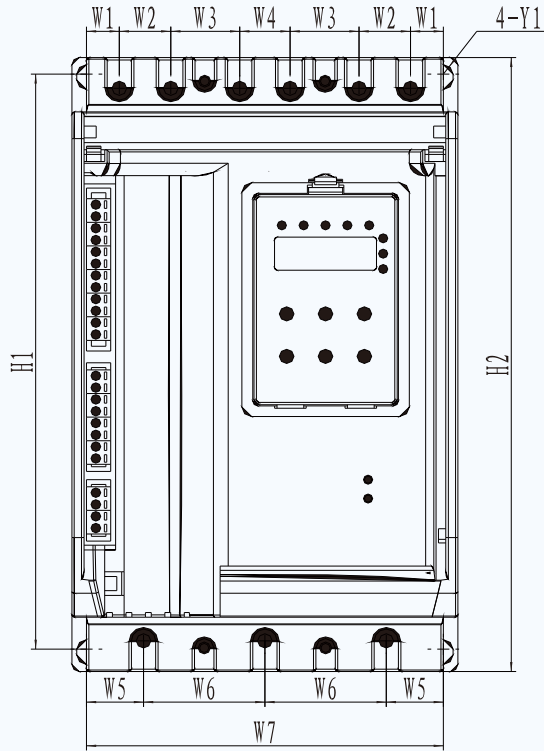

● M1 Outline dimension



 Please check the parameters in accordance with the above picture.

Model	Dimension(mm)															
	W1	W2	W3	W4	W5	W6	W7	W8	D1	D2	D3	D4	D5	H1	H2	Y1
M1	13.5	21.2	28.4	20.7	23.5	50	147	159	190	92	14	21.5	70.5	243.5	260	Φ8 × 10.5

● M2/M3/M4/M5 Outline dimension

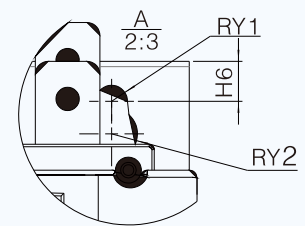
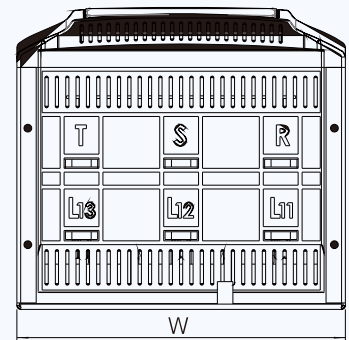
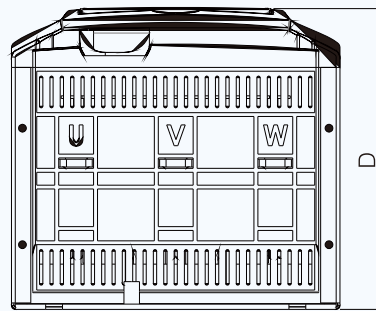
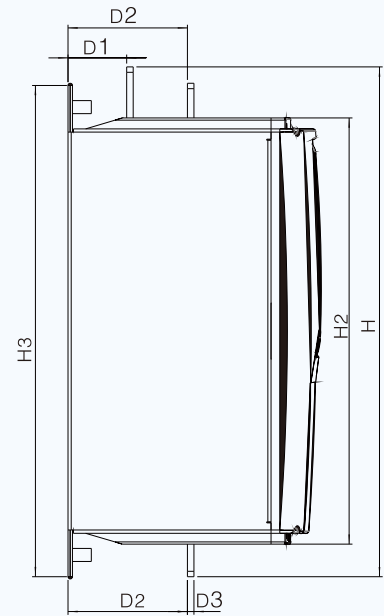
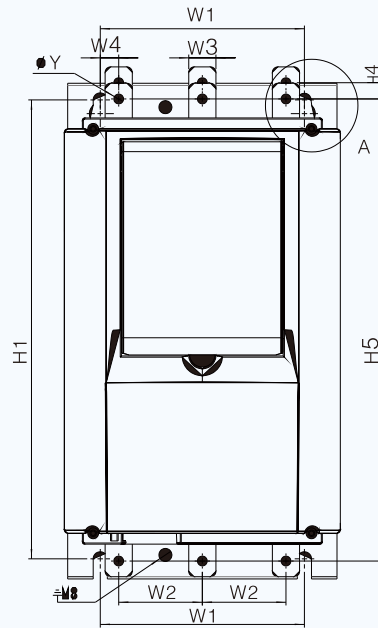

Please check the parameters in accordance with the above picture.

Model	Dimension(mm)																		
	W	W1	W2	W3	W4	D	D1	D2	D3	H	H1	H2	H3	H4	H5	H6	Y	Y1	Y2
M2	254	188	77	25	17	226	54	110	6	474	418	392	446	8.5	429	12	9	5.5	10
M3	290	224	89	31	23	247	74	130	6	552	472	452	506	4.5	497	15.5	13	5.5	10
M4	326	260	101	37	29	273	92	150	8	605	515	495	549	-0.5	550	15.5	13	6.5	11
M5	404	338	127	50	42	318	128	188	10	754	626	606	660	-4	669	15.5	13	6.5	11

## ● Product Specification

380/500V(+10%-15%)50/60Hz(±2%)			Applicable motor rated power			
Structure model	Product Model	Rated current Ie(A)	Outside wiring		Inside wiring	
			380(kW)	500(kW)	380(kW)	500(kW)
M1	JJR5000-11-□	11	5.5	7.5	7.5	11
	JJR5000-15-□	15	7.5	11	11	18.5
	JJR5000-22-□	22	11	15	15	22
	JJR5000-30-□	30	15	18.5	22	30
	JJR5000-37-□	37	18.5	22	30	37
	JJR5000-45-□	45	22	30	37	45
	JJR5000-60-□	60	30	37	45	55
	JJR5000-75-□	75	37	45	55	75
	JJR5000-90-□	90	45	55	75	95
	JJR5000-110-□	110	55	75	95	115
M2	JJR5000-145-□	145	75	95	115	132
	JJR5000-190-□	190	95	115	132	160
	JJR5000-220-□	220	115	132	160	200
M3	JJR5000-250-□	250	132	160	185	250
	JJR5000-300-□	300	160	200	200	320
	JJR5000-350-□	350	185	220	250	350
M4	JJR5000-390-□	390	200	250	320	400
	JJR5000-480-□	480	250	320	400	500
	JJR5000-600-□	600	320	400	500	600
	JJR5000-670-□	670	350	450	600	700
M5	JJR5000-720-□	720	385	500	650	800
	JJR5000-800-□	800	400	550	700	900
	JJR5000-950-□	950	500	650	800	1100
	JJR5000-1150-□	1150	600	800	1000	1350
	JJR5000-1350-□	1350	700	900	1200	1550
	JJR5000-1500-□	1500	800	1000	1350	1700

## ● Outside Wiring Drawing

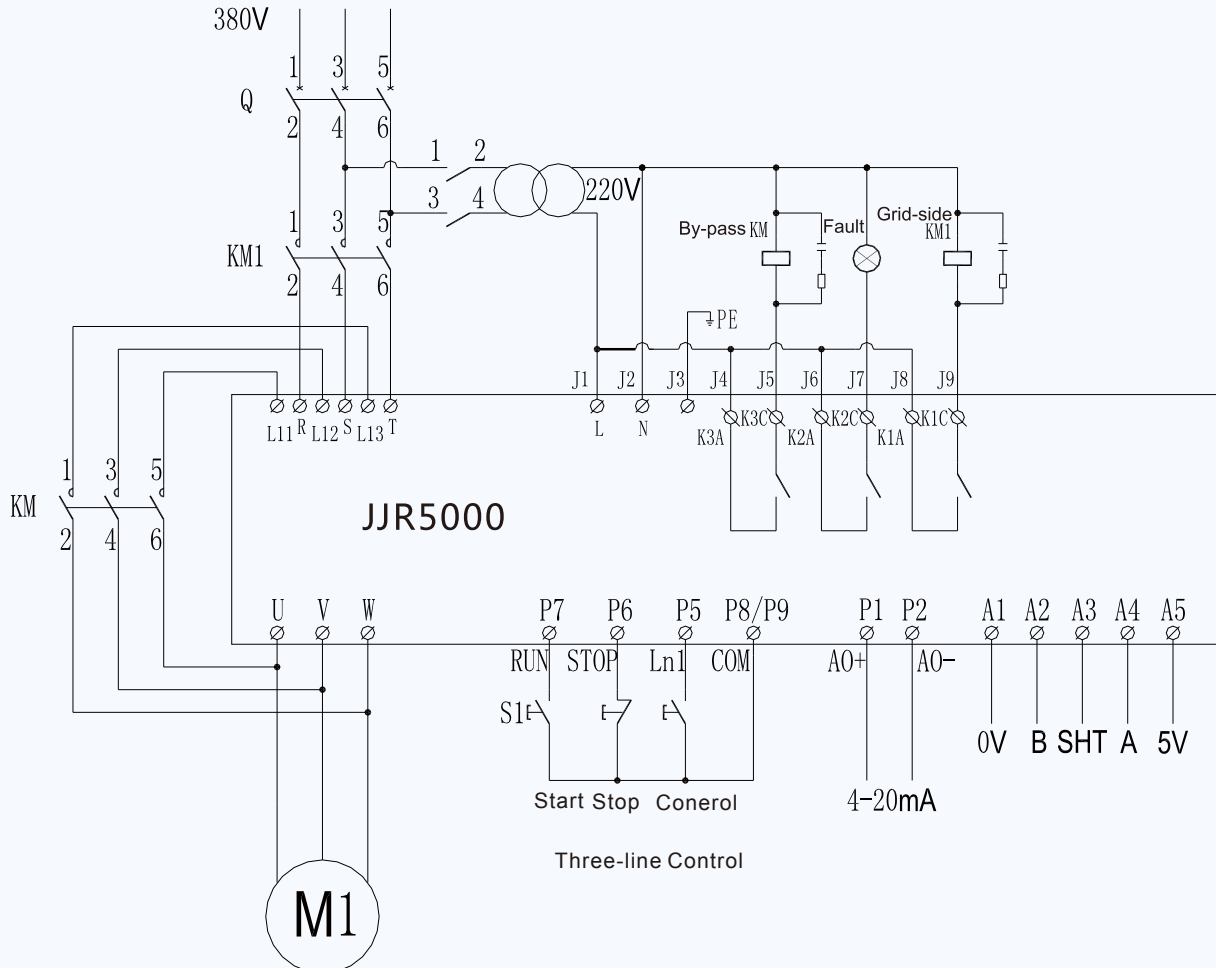

### Instruction:

1. Main loop wiring: Terminal R-S-T connect power supply; Terminal U-V-W connect motor
2. Control power supply wiring: it connects control loop terminal J1 and J2.
3. Ground wiring: it connects control loop J3.
4. K3 controls bypass contactor. K1 and K2 are programmable relay output. They are pass contacts.
5. Start and stop loop wiring: Follow circuit diagram to connect control loop terminals P6, P7, P8 and P9.
6. P4 and P5 are programmable input terminals. P3 is temperature inspecting terminal.
7. P1 and P2 are 4-20mA analogue signal output terminals.
8. A1, A2, A3, A4 and A5 are RS485 communication terminals.

# Secondary Wiring Drawing

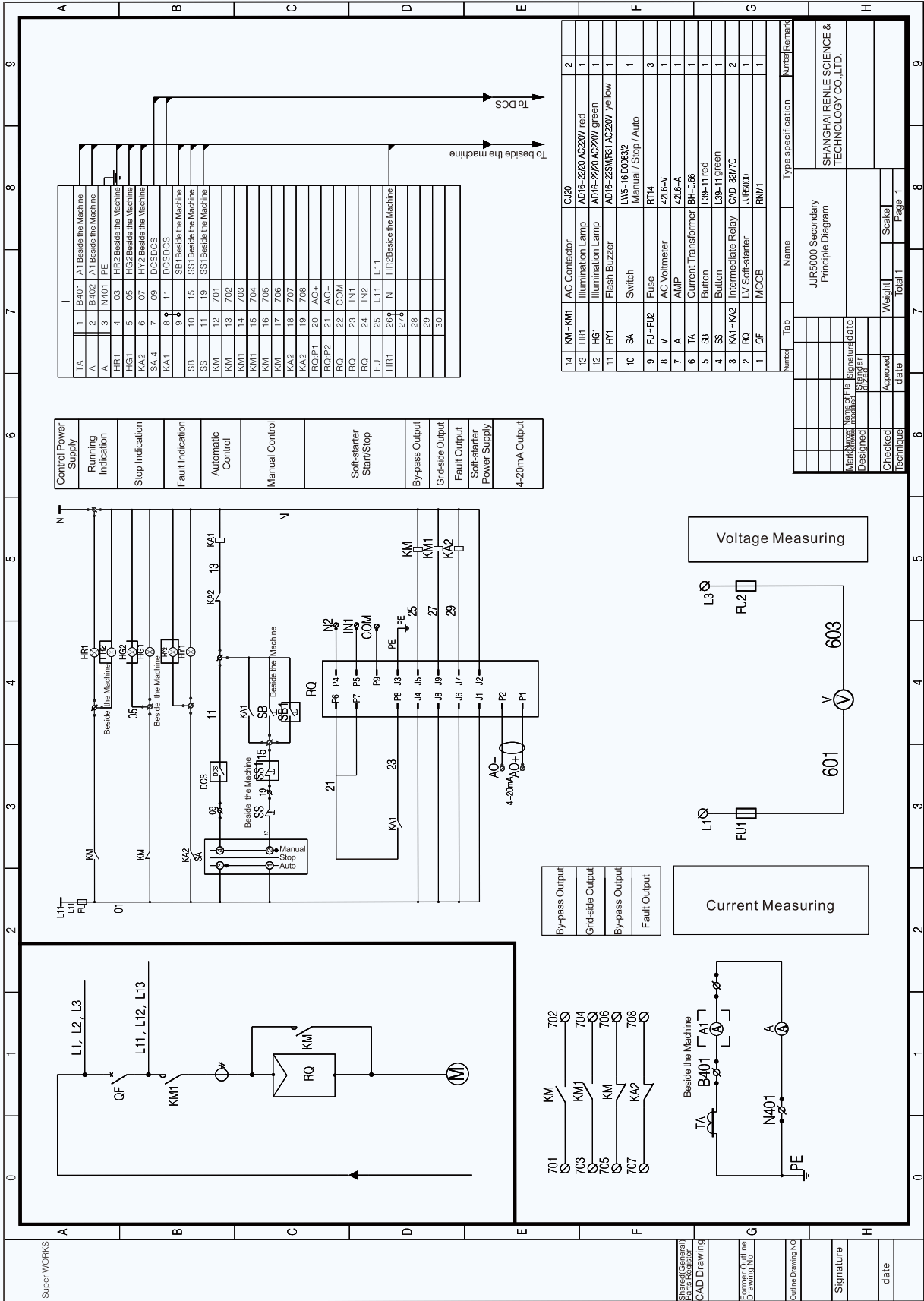

Super WORKS

Sheet(General Parts Assembly)

CAD Drawing

Electrical Outline Drawing No.

Outline Drawing No.

Signature

date

Weight Total 1

Scale Page 1

Number Tab Name Type specification Number/Remark

JJRS000 Secondary Principle Diagram

SHANGHAI RENLE SCIENCE & TECHNOLOGY CO.,LTD.

Checked/Technique

Approved/Signature

Designated/Signature

Marked/Signature

Number of the Drawing

Signature/date

Signature/date

Signature/date

Signature/date

Signature/date

Signature/date

Signature/date

Signature/date

Signature/date

Signature/date

Signature/date

Signature/date

Signature/date

Signature/date

## National Key Projects



Three Gorges Project  
 Beijing Olympic Rowing-Canoeing Park  
 Beijing Olympic Games Supporting Projects  
 Beijing Wukesong Gymnasium  
 Government Offices Administration of the State Council  
 CCTV, China



Beijing Capital International Airport  
 South-to-North Water Diversion Project  
 Huangshan-Quzhou-Nanping Expressway  
 West-to-East Electricity Transmission Project  
 West-to-East Natural Gas Transmission Project  
 Stations of Shanghai Magnetic Levitation Rail Transportation



Expo 2010 Shanghai China Supporting Projects  
 Shanghai Pudong Airport  
 Shanghai International Automobile Museum  
 Shanghai Hongqiao Airport Extension Project  
 Terminal of Inner Mongolian Hohhot Baita International Airport Extension Project  
 Shenyang Olympic Center



Qingdao Olympic Center  
 Jinan Olympic Center  
 Chengdu Shuangliu International Airport Extension Project  
 Chongqing Yuanjiagang Olympic Sports Center  
 Guangzhou New Baiyun International Airport  
 Wuhan Tianhe Airport  
 Shanghai Metro Line 3



Shanxi Wanjiashai Yellow River Diversion Project  
 Qinghai Xiaoyou Mountain Ecological Engineering  
 Tianjin Eight Large Regions Heating Engineering  
 Shandong Heze City Yellow River Diversion Project  
 Guangxi Longtan Hydroelectric Project  
 Gansu Satellite Launching Center

## National Key Projects



Yangshan Deepwater Port Project of Shanghai International Shipping Center

Sichuan Xichang Satellite Launching Center

Taizhou Petrochemical Co., LTD

Anshan Iron and Steel Group Corporation

Jilin Petrochemical Company

Wuhan Iron and Steel (Group) Corp.

Liuzhou Chemical Industry Co., Ltd, Guangxi

Beijing Shougang Company Limited

SINOPEC Cangzhou Company

China Great Wall Aluminum Corporation

SINOPEC Luoyang Company

Guangxi Pingguo Aluminium Company

Yueyang Petrochemical Factory

Liuzhou Iron and Steel Co., Ltd

Sinopec Nanjing Chemical Industry Co., Ltd

Magang (Group) Holding Company Ltd

SINOPEC Beijing Yanshan Company

Shanxi Zhongyang Iron and Steel Co., Ltd.

PetroChina Urumqi Petrochemical Company

Daqing Oilfield Limited Company

PetroChina Jinxi Petrochemical Company

SINOPEC Shenli Oilfield

CNPC Dushanzi Petrochemical Company

PetroChina Liaohe Oilfield

Beijing Financial Street

PetroChina Tarim Oilfield

Panda Museum of Chengdu Panda Ecological Park

Karamay Oilfield

Qingdao Beihai Shipyard

PetroChina Changqing oilfield

Inner Mongolian Shenhua Group Corporation Limited

Shanghai Petrochemical Company Limited

Baosteel Group Corporation in Shanghai

Chongqing International Convention & Exhibition Center

Yunnan Honghe River Nansha Hydropower Station

Datang International Power Generation Co., Ltd.